

Part # **PLCC68**

Leads **68** Pitch **1.27mm (50mils)**

Body Size **24.2mm (.95" SQ)**

Dwg **PLCC68.pdf**

TopLineTM

Tel 1-714-898-3830

info@topline.to

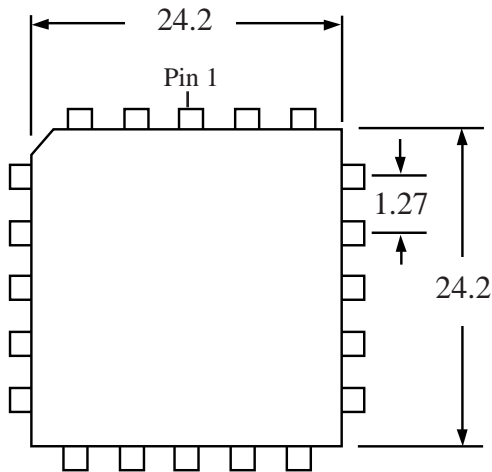

Top View

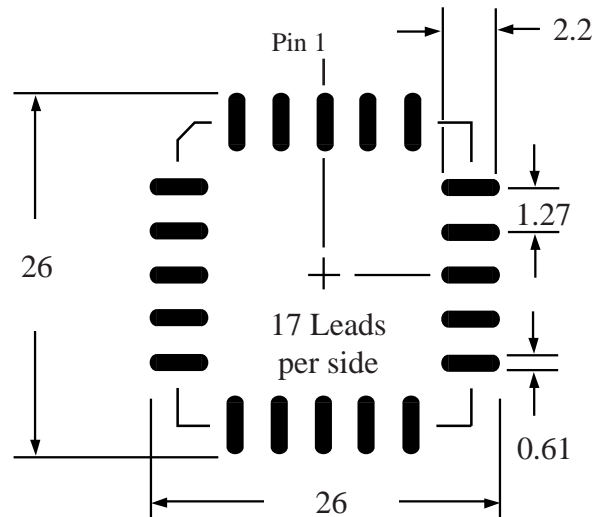

PC Board

Dimensions = mm

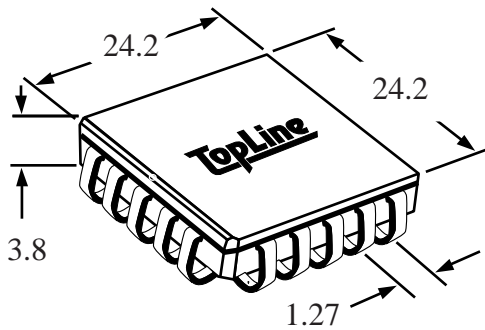

Quick View

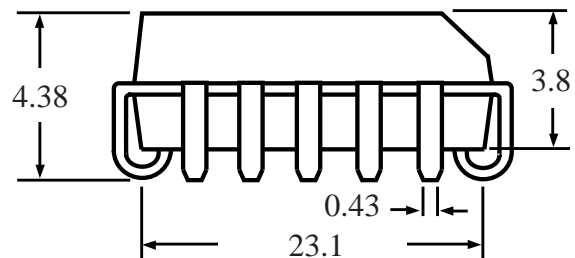

Side View Detail